

Fault diagnosis of shunt capacitors based on decision tree

WANG XIAOHUI², ZHU YONGLI², GUO
FENGJUAN², WANG YAN²

Abstract. The paper first analyzes the structure and fault cause of shunt capacitor. And then, based on the on-line monitoring system of capacitor, a fault diagnosis decision tree method based capacitor fault identification method is proposed. The decision attributes of decision tree include voltage, current, capacitance and dielectric loss. The fault diagnosis example shows that the fault diagnosis method of capacitor tree is effective and can find the potential fault of capacitor.

Key words. Capacitor, fault diagnosis, decision tree, on-line monitoring.

1. Introduction

Shunt capacitor is an important device to maintain the balance of reactive power balance, to maintain stability of grid voltage and to reduce the transmission energy loss. In addition, capacitors play an important role to improve power quality. However, capacitor works at high electric fields and poor working conditions for a long time, and its failures are common, so its safe operation and fault handling is very important.

Traditional regular maintenance cannot meet the requirements for capacitor's safe operation, online monitoring and fault diagnosis technology has become an inevitable trend of capacitor maintenance. However, the monitor object of these systems is limited to entire shunt capacitor bank, and a single capacitor's operating parameters' cannot be monitored. Therefore, even if abnormal operation is found, the capacitor cannot be determined. Limitations of monitoring system make existing capacitor fault diagnosis method is rarely, and the method includes infrared diagnostic technique^[6], artificial neural networks^[7], Bayesian networks^[8], etc. Infrared detection is an effective mean of charged monitoring, but the measured temperature is affected by wind speed, emissivity, measuring distance and surface leakage

¹ Acknowledgements-This work was supported by the National Natural Science Fund (51677072) and the Fundamental Research Funds for the Central Universities (2014MS132).

² Workshop 1 - Dept. of computer, North China Electric Power University, Baoding, China

current, therefore it is difficult to make the result as the basis for quantitative analysis. Artificial neural networks and Bayesian network are knowledge based artificial intelligence method. Both methods have a high reasoning rate, but the knowledge representation of networks is obscure, and the knowledge acquisition requires a large amount of data samples. So it is necessary to build an effective online monitoring system and to propose a failure evaluation method for capacitor.

2. Capacitor diagnosis analysis and online monitoring system

2.1. Capacitor structure and diagnosis analysis

There are two kinds of capacitor structure, capacitor without fuse and serial-parallel structure and capacitor with internal fuse and parallel-serial structure. Here take capacitor with internal fuse and parallel-serial structure as an example, the structure is shown in Figure 1.

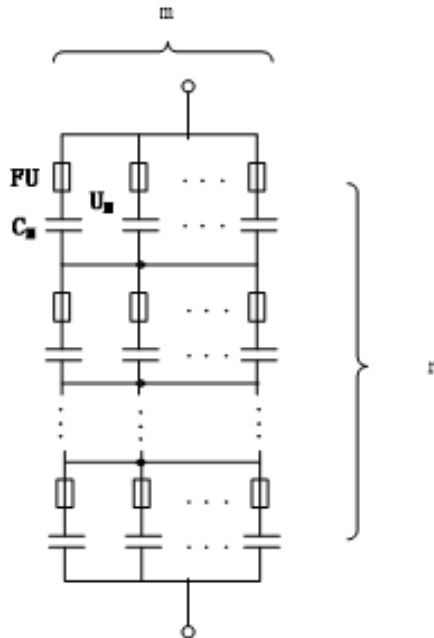

Fig. 1. Internal wiring diagram of capacitor with fuse and parallel-serial structure

In Figure 1, FU is the internal fuse, C_N is the rated capacitance value of capacitor component, U_N is the rated voltage value of capacitor component. Then the capacitance of capacitor with m parallel- n serial structure (shown in Figure.1) is $C_{CN} = \frac{m}{n} C_N$.

When breakdown occurs in a component, all components in parallel circuit will discharge to the failure point, which will cause the fault component's fuse disconnect

quickly. In this case, the capacitance value of fault unit is $C_g = \frac{m(m-1)}{n(m-1)+1} C_N$, the ratio of fault capacitance value to the pre-fault that is $\frac{C_g}{C_{CN}} = \frac{m(m-1)}{n(m-1)+1}$. Obviously, the capacitance value of fault unit is reduced. Meanwhile, the voltage of other capacitor component in parallel circuit increases, and the voltage of series segment decreases. Therefore, the decision rule can be summarized.

Capacitor in operation will produce active power loss due to the following reasons, such as dielectric polarization, drain conductance, internal resistor, internal partial discharge and etc. Through monitoring the dielectric loss tangent ($\tan \delta$), the quality of the capacitor's dielectric material can not be checked, but also find the insulation deterioration problems in running capacitor. Therefore, on the basis of capacity, voltage and current analysis and combining with $\tan \delta$, the evaluation process of capacitor unit's overall state can be shown in Figure 4. The specific state evaluation depends on the parameters' permitted range of normal capacitor and the minor alarm value and serious alarm value of each parameter. The parameter includes capacitance, voltage, current and $\tan \delta$.

2.2. capacitor online monitoring system

Using AC current induction power supply, the monitoring systems based on GPS in the high potential side of bus, which logical structure is shown in Figure 2. In this system, current transformer (CT) and potential transformer (PT) measure working current and working voltage respectively and synchronously for individual capacitor. Monitoring data is transferred to the server through wireless sensor networks, and then every capacitor is diagnosed by the following failure evaluation method. The monitoring system measures each individual capacitor's current and voltage in the charged side, so it is possible to effectively monitor each individual capacitor's state, and to further achieve precise positioning.

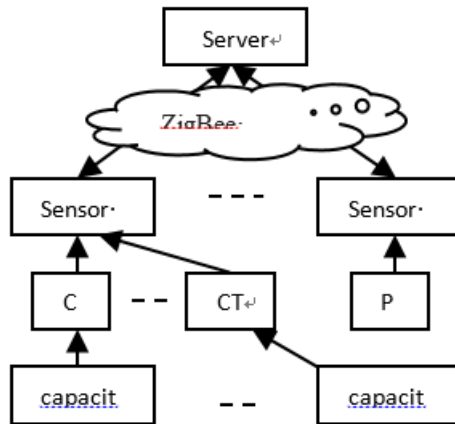

Fig. 2. Logical structure of capacitor monitoring system

3. Decision tree diagnosis model of capacitor

3.1. Decision tree knowledge representation

Knowledge representation is a description agreement for expert's knowledge, whose purpose is to represent human knowledge into machine's data structure. Good knowledge representation can not only improve the effectiveness and efficiency of knowledge storage, but also improve the efficiency of artificial intelligence reasoning systems.

Decision tree can be regarded as a classification tree. In this tree, each node is a sub-division problem, and data set is divided into two or more blocks by this node's test property. Sub-node is growing until generating leaf node which is some category. A path from root node to leaf node forms a classification rule. Therefore, decision tree's knowledge representation is to implicitly represent expert knowledge on the tree's internal nodes and leaf nodes. The properties of the internal nodes and their values express the knowledge's condition part, and the conclusion of knowledge is obtained in the leaf nodes^[8].

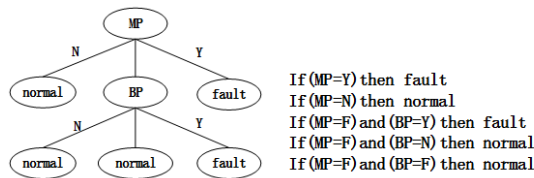

Fig. 3. Fault diagnosis decision tree and its rules

Figure 3 shows the decision tree including two nodes expresses five production rules, so the decision tree has a strong ability for knowledge representation. Seen from the perspective of knowledge reasoning, we can reach the conclusion by two-step in the worst case (the depth of decision tree is 2), and hence the decision tree has a high reasoning rate.

3.2. generation of diagnosis model for capacitor Decision tree

Based on the fault characteristic of capacitor, a decision tree based on multi information fusion evaluation method for capacitor state evaluation is established, which comprehensive utilize the information such as, the capacitance of capacitor, current, voltage and dielectric loss tangent information to determine the comprehensive state of capacitor. The method is simple, reliable and beneficial to the development of state maintenance work of capacitor. There have two methods to build decision tree, including ID3 method and C4.5 method ^[8]. Corresponding to the ID3 algorithm, C4.5 algorithm made some improvements, such as using information gain as evaluation criteria and Continuous numeric attribute processing.

3.2.1. *Using information gain rate to select attributes* C4.5 adopts a depth-first strategy, using the gain ratio, as a split criterion, resulting in reduced bias in favour of many-valued attributes, as compared to algorithms that use the information gain (ID3 Algorithm). D denotes sample set. it is assumed that the discrete attribute ‘a’ has V discretization of possible values (a^1, a^2, \dots, a^v). D^v denotes the sample number for the value of a is D^v in sample set D. $\text{Ent}(D^v)$ denotes information entropy. The information gain obtained by dividing the sample set D with the attribute a can be calculated by formula (4).

$$\text{Gain}(D, a) = \text{Ent}(D) - \int_{v=1}^V \frac{|D^v|}{|D|} \text{Ent}(D^v) \tag{1}$$

The gain ratio can be calculated by the following formula(5).

$$\text{Gain_ratio}(D, a) = \frac{\text{Gain}(D, a)}{\text{IV}(a)} \tag{2}$$

Here:

$$\text{IV}(a) = - \int_{v=1}^V \frac{|D^v|}{|D|} \text{Log}_2 \frac{|D^v|}{|D|} \tag{3}$$

3.2.2. *Continuous value and missing value processing* The algorithm, however, was also considered to be biased in favor of continuous attributes, this being the reason for improvements proposed later. Splits in continuous values are binary, dividing the search space into two disjoint parts. In some cases, the sample data may be missing values for some attributes. Unknown values are not treated as extra ones. They are ignored in the training phase resulting in classification errors. The probability of various possible results is estimated in the case of unknowns during testing.

3.2.3. *Application of pre-pruning technique* C4.5 employs a pruning technique that replaces subtrees with leaves, the method uses the training sample set itself to estimate the error of before and after pruning, so as to determine whether the real pruning and reduce overfitting and training time.

4. Case Study

The proposed method needs to monitor the values of C_{CN}, I_{CN}, U_{CN} and $\tan\delta$ of dielectric loss angle. The author accumulated the actual online monitoring data through the on-line monitoring project of the capacitor group in a substation. Here, each phase of the monitored capacitor group ABC three phases is installed 8 shunt capacitors. Monitoring the operating current of each capacitor using CT and The working voltage of each phase capacitor group is calculated by monitoring the PT voltage. The dielectric loss angle is calculated by synchronous measuring the difference between the working current and the voltage of the capacitor.

After a period of online monitoring, A phase and C phase are not found fault ca-

capacitor and 5# capacitor of B phase is failure. The C_{CN} of B phase shunt capacitors is shown in Figure 4.

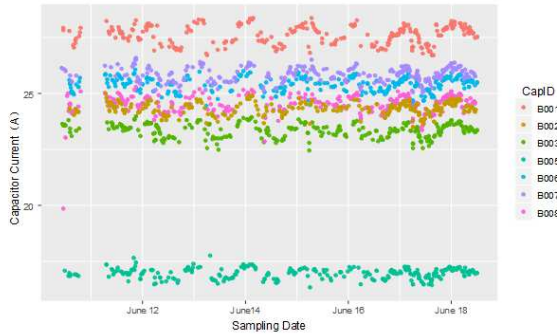

Fig. 4. C_{CN} of B phase shunt capacitors

The capacitor are not put into operation at June 11th afternoon. So here lack of the monitored data of that time. It can be seen from the monitored data that the current value of the ‘B005’ capacitor is obviously smaller than that of the other capacitors. After the off-line inspection, it finds that the capacitor fuse is fault, the monitored value is marked as ‘1’ (BD1).

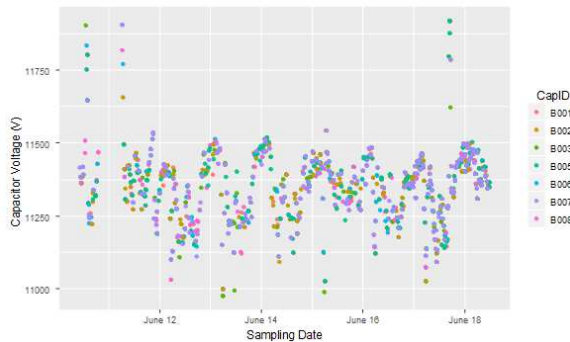

Fig. 5. U_{CN} of each capacitor in the B phase

The working voltage U_{CN} of each capacitor in the B phase is shown in Figure 5.

The capacitance (C_{CN}) of each capacitor in the B phase is shown in figure 6.

The dielectric loss value density function of each capacitor of B phase is shown in Figure 7.

It can be seen from the figure 7 that the dielectric loss value distribution is not exactly the same. Training different decision trees for different capacitors can improve the classification accuracy of decision trees.

Based on the same sample monitoring data, the C4.5 method based decision tree is built, as shown in figure 8.

The above decision tree has more information and the main decision attribute is capacitor current. If the capacitor working current is less than 17.98A, the capacitor



Fig. 6. C_{CN} of each capacitor of B phase

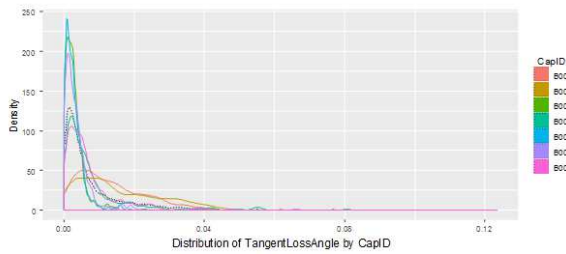

Fig. 7. dielectric loss value $\tan\delta$ density diagram of each capacitor of B phase

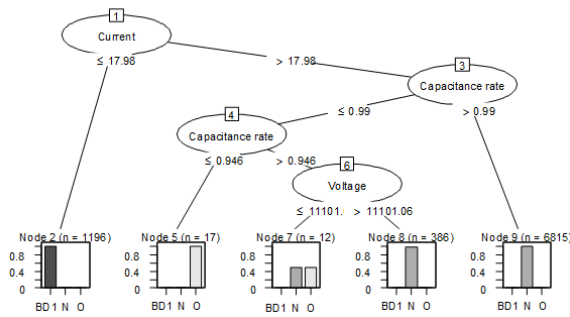

Fig. 8. Fault diagnosis decision tree for capacitor

is classified as ‘BD1’ type. If the working current is normal and C_{CN} is bigger than 99% rated capacitance, the capacitor is classified as normal (‘N’ type). If the monitored C_{CN} is bigger than 95% rated capacitance, the capacitor is classified as outlier point (‘O’ type). When the rated capacitance is reduced by more than 5% and the working voltage is less than 11kV, the 12 samples may be outliers, but also may be the normal data. The correct rate of the whole decision tree is 99.83%. The specific classification is shown in Table 1.

Table 1.C4.5 Classification results

BD1	BD1	O	N	Classification error rate	Classification error number
O	1196	0	0	0	0
M	0	27	8	22.86%	8
sum	1196	33	7197	0.17%	14

It can be seen from Table 1, The classification accuracy of BD1 type and N type is very high. There is a large classification error Because of the existence of ‘O’ type data causing by interference.

5. Conclusion

In this paper, based on the analysis of the capacitor structure and the causes of the fault, an on-line monitoring system for capacitors is constructed and the fault diagnosis method based on fault diagnosis decision tree is proposed. The decision attribute of capacitor fault diagnosis decision tree is constituted by voltage, current, capacitance and dielectric loss. The decision tree structure is learned by C4.5. Monitoring and diagnosis example shows the fault diagnosis method of capacitor tree decision tree proposed in this paper is effective and can find the potential fault of capacitor well.

References

- [1] LI. SHENGCHUAN,GAO. DIANYING: *Analysis and precaution of a 66kV capacitor failure*. Power capacitor & Reactive Power compensation 30 (2009), No. 3, 51–56.
- [2] LIANG. YIMING,SHI. MINGBIAO: *Analysis of the fault in 66kV high voltage shunt capacitors*.Power capacitor & Reactive Power compensation 30 (2009), No. 2, 41–44.
- [3] WANG. WENHONG,HE. MANTANG: *Analysis on colony fusing failure of fuses in shunt capacitor bank*.Power Capacitor28 (2007), No. 6, 51–53.
- [4] MIAO. JUNJIE,DU. DAQUAN: *Cause analysis on high fault rate of assembling capacitor made from 1998 to 2004*.Hebei Electric power 28 (2009), No. 4, 9–10.
- [5] MIAO. ZHUMEI,NI. XUEFENG: *Investigation of operation condition for HV shunt capacitor device*.Electrical Equipment 5 (2004), No. 9, 21–24.
- [6] SHEN. JUN: *An Example of Infrared Methods for Fault-diagnosis of Coupling Capacitors*.High Voltage Engineering 27 (2001), No. 2,80–81.
- [7] WANG. YONGQIANG,LU. FANGCHEN: *Fault diagnosis for capacitive equipments based on Bayesian Network*.33 (2017), No. 9, 222–225.
- [8] ZHANG. YANSONG,ZHAO. YINGKAI: *Fault diagnosis of substation by the constructed decision tree based on principal component analysis(PCA) and rough set*.Power System Protection and Control 38 (2010), No. 14, 104–109.

Received November 16, 2016